RESERVEDELSSKISSE

Utriggere



30. APRIL 2024

SMÅBÅTHAVNER AS

Disenåvegen 47 – 2100 Skarnes







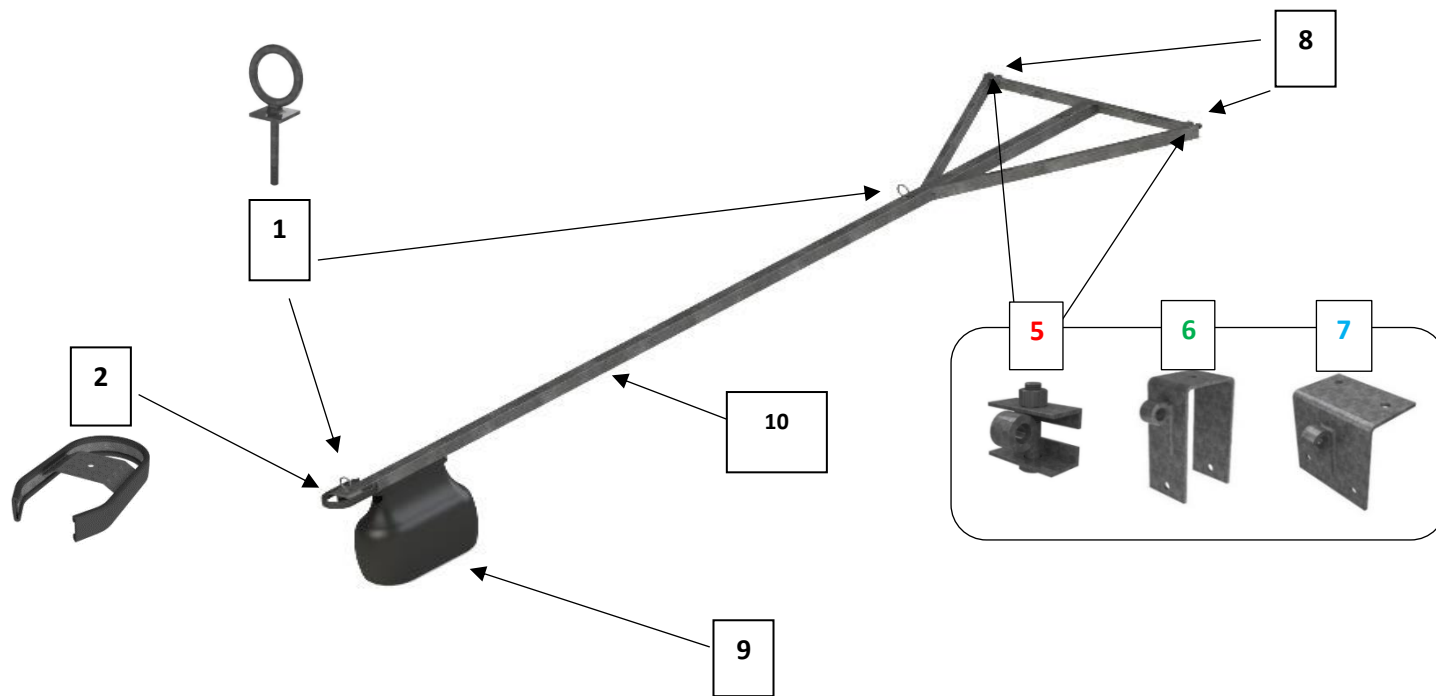









Innholdsfortegnelse

Fortøyningsbommer	2
Fortøyningsbommer sammensetningstabell	3
Gangbar utrigger med tredekke	4
Gangbar utrigger med tredekke – sammensetningstabell	5
Gangbar utrigger med strekkmetalldekke	6
Gangbar utrigger med strekkmetalldekke – sammensetningstabell (side 1)	7
Gangbar utrigger med strekkmetalldekke – sammensetningstabell (side 2)	8

Fortøyningsbommer



FORTØYNINGSBOMMER SAMMENSETNINGSTABELL

Nr	Bilde	Beskrivelse	Lengde på utrigger									
			Varenr. 20-50		Varenr. 20-60		Varenr. 20-70		Varenr. 20-80		Varenr. 20-100	
			5 meter	6 meter	7 meter	8 meter	10 meter					
1		Fortøyningsringer	60-200	2	60-201	2	60-203	2	60-204	2	60-204	2
1		Skive til fortøyningsringer	16-12	2	16-12	2	16-12	2	16-12	2	16-12	2
1		Mutter til fortøyningsringer	13-12	2	13-12	2	13-12	2	13-12	2	13-12	2
2		Endefender (med ferdig montert fenderlist)	60-226	1	60-226	1	60-226	1	60-226	1	60-226	1
2		Sort fenderlist til endefender	60-225	1	60-225	1	60-225	1	60-225	1	60-225	1
9		Pontong	80-077	1	80-077	1	80-077	1	80-077	2	80-077	3
9		Bolt for feste av pontong	11-12100	2	11-12130	2	11-12130	2	11-12150	4	11-12150	6
9		Skive for bolt til pontong	16-12	4	16-12	4	16-12	4	16-12	8	16-12	12
9		Mutter for bolt til pontong	13-12	2	13-12	2	13-12	2	13-12	4	13-12	6
10		Stålramme standard	S20-50	1	S20-60	1	S20-70	1	S20-80	1	S20-100	1
		<i>Alternativ stålramme ved avslutninger:</i>										
10		Stålramme avslutning høyre	S20-50H	1	S20-60H	1	S20-70H	1	S20-80H	1	-	-
10		Stålramme avslutning venstre	S20-50V	1	S20-60V	1	S20-70V	1	S20-80V	1	-	-
		Velg festebeslag (enten 5, 6 eller 7):										
5		T-skinnebeslag	60-214	2	60-214	2	60-214	2	60-214	2	60-214	4
6		Klammerbeslag 90mm	60-212	2	60-212	2	60-212	2	60-212	2	60-212	4
6		Klammerbeslag 95mm	60-211	2	60-211	2	60-211	2	60-211	2	60-211	4
6		Klammerbeslag 128mm	60-213	2	60-213	2	60-213	2	60-213	2	60-213	4
7		Faste beslag m1/emningsrør	60-208	2	60-208	2	60-208	2	60-208	2		
7		Faste beslag m/2 emningsrør									60-209	2
8		Bolt som fester beslag til utrigger	11-18110	2	11-18110	2	11-18110	2	11-18110	2	11-18160	2
8		Mutter til bolt	13-18	2	13-18	2	13-18	2	13-18	2	13-18	2

Gangbar uttrigger med tredekke

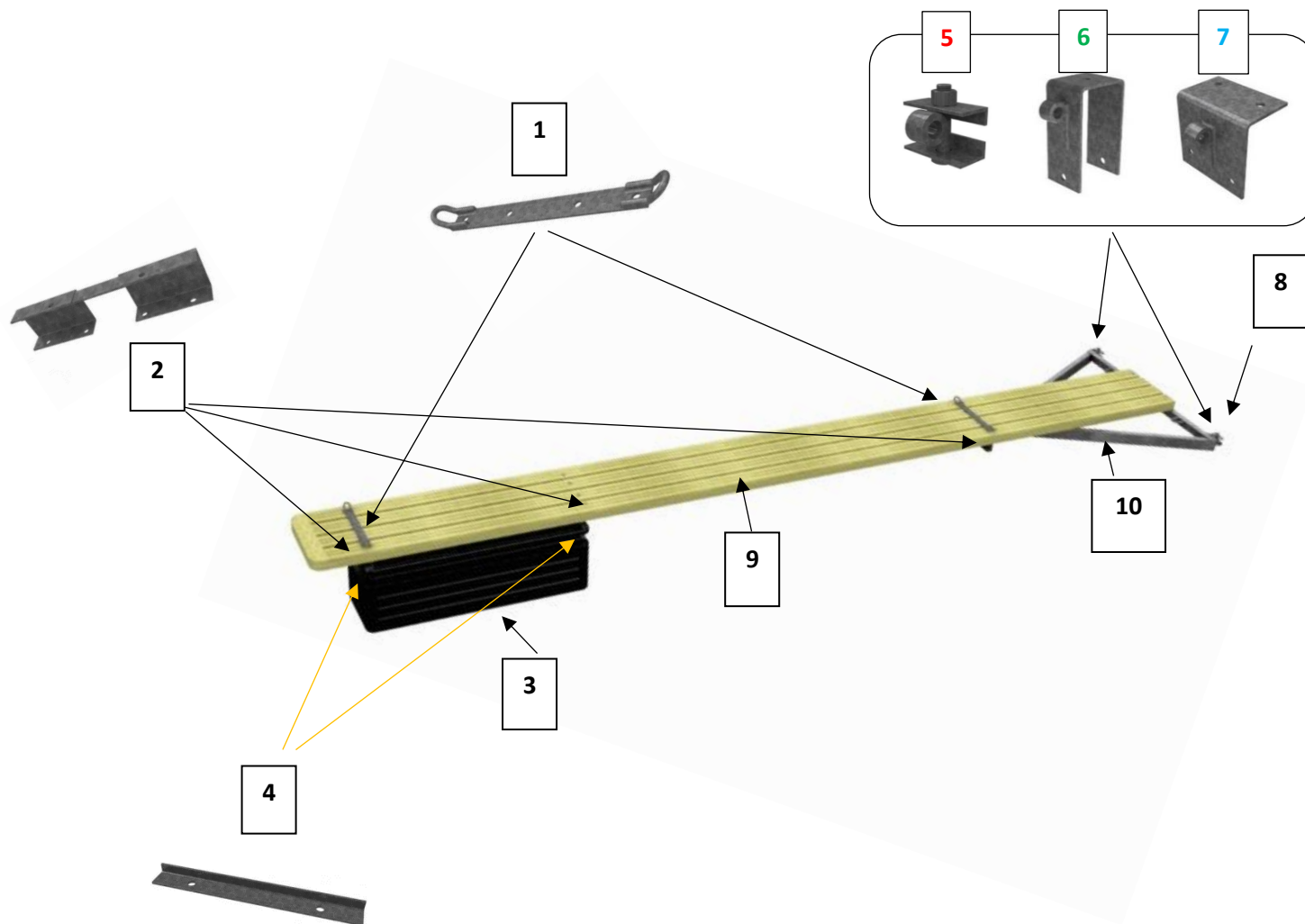







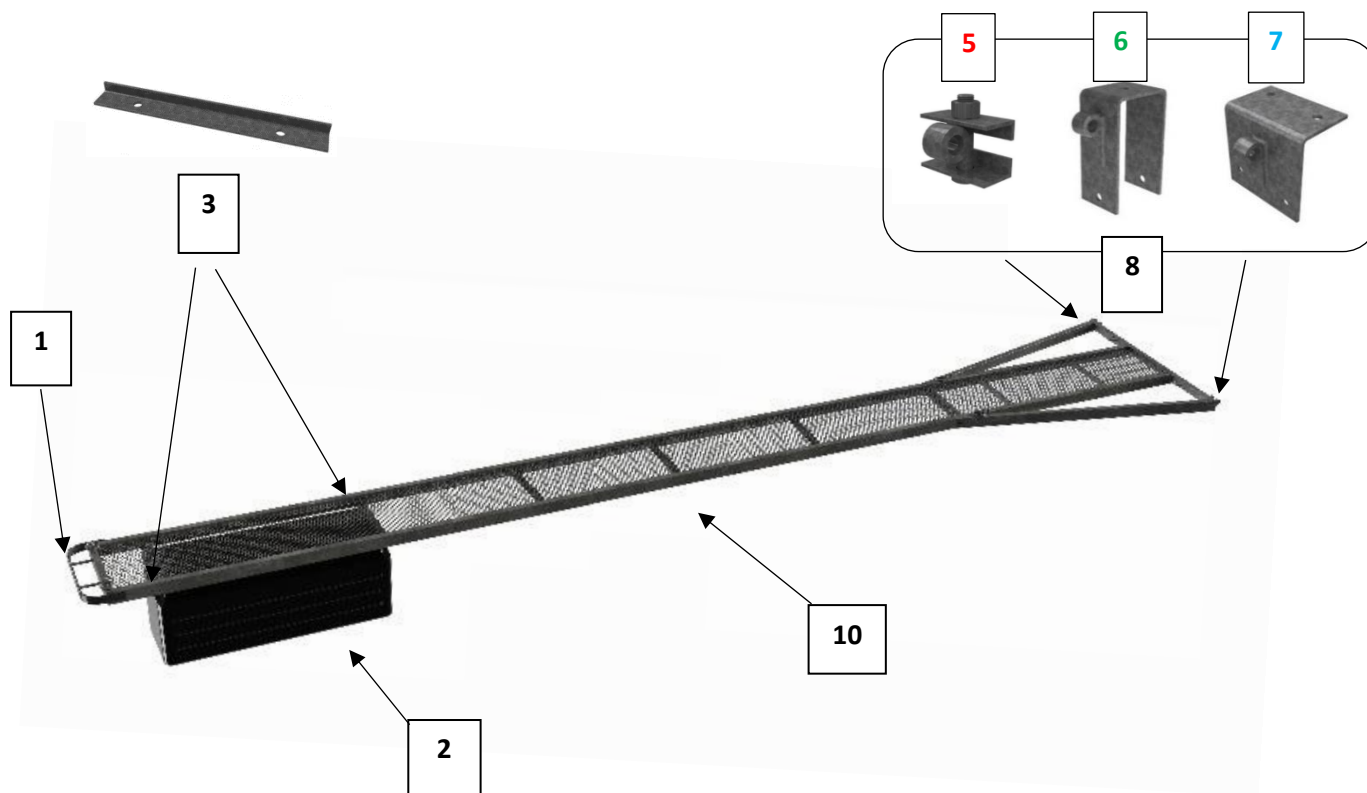





GANGBAR UTRIGGER MED TREDEKKE – SAMMENSETNINGSTABELL

Nr	Bilde	Beskrivelse	Lengde på uttrigger									
			Varenr. 30-50		Varenr. 30-60		Varenr. 30-70		Varenr. 30-80		Varenr. 30-80B	
			5 meter	6 meter	7 meter	8 meter / lett	8 meter / bet	5 meter	6 meter	7 meter	8 meter / lett	8 meter / bet
			Varenr.	Stk	Varenr.	Stk	Varenr.	Stk	Varenr.	Stk	Varenr.	Stk
1		Flattjern m/hemper	60-205	2	60-205	2	60-205	2	60-205	2	60-205	2
1		Låsebolter til flattjern m/hemper inkl. mutter	18-10060	8	18-10100	8	18-10100	8	18-10100	8	18-10100	8
2		Låsebolter til «Beslag for trelem» inkl. mutter	18-10060	8	18-10100	8	18-10100	12	18-10100	16	18-10100	16
2		Beslag for trelem	60-206	4	60-206	4	60-206	5	60-207	6	60-207	6
3		Pontong	80-330	1	80-330	1	80-330	1	80-330	2	80-370	1
4		Pontongvinkel	60-217	2	60-217	2	60-217	2	60-217	4	60-217	2
4		Bolter M12x75 til pontongvinkel	11-12075	4	11-12075	4	11-12075	4	11-12075	8	11-12075	4
4		Mutter M12 til pontongvinkel	13-12	4	13-12	4	13-12	4	13-12	8	13-12	4
9		Trelem, komplett uten bolter	70-5000	1	70-6000	1	70-7000	1	70-8000	1	70-8000	1
10		Stålramme standard	S20-50	1	S20-60	1	S20-70	1	S20-80	1	S20-80	1
		<i>Alternativ stålramme ved avslutninger:</i>										
10		Stålramme avslutning høyre	S20-50H	1	S20-60H	1	S20-70H	1	S20-80H	1	S20-80H	1
10		Stålramme avslutning venstre	S20-50V	1	S20-60V	1	S20-70V	1	S20-80V	1	S20-80V	1
		Velg festebeslag (enten 5, 6 eller 7):										
5		T-skinnebeslag	60-214	2	60-214	2	60-214	2	60-214	2	60-214	2
6		Klammerbeslag 90mm	60-212	2	60-212	2	60-212	2	60-212	2	60-212	2
6		Klammerbeslag 95mm	60-211	2	60-211	2	60-211	2	60-211	2	60-211	2
6		Klammerbeslag 128mm	60-213	2	60-213	2	60-213	2	60-213	2	60-213	2
7		Faste beslag m1/emningsrør	60-208	2	60-208	2	60-208	2	60-208	2	60-208	2
7		Faste beslag m/2 emningsrør	60-208	2	60-208	2	60-208	2	60-208	2	60-208	2
8		Bolt som fester beslag til uttrigger	11-18110	2	11-18110	2	11-18110	2	11-18110	2	11-18110	2
8		Mutter til bolt	13-18	2	13-18	2	13-18	2	13-18	2	13-18	2















Gangbar uttrigger med strekkmetalldekte



GANGBAR UTRIGGER MED STREKKMETALLDEKKE – SAMMENSETNINGSTABELL (SIDE 1)

Nr	Bilde	Beskrivelse	Lengde på utrigger											
			Varenr. 40-50		Varenr. 40-60		Varenr. 40-70		Varenr. 40-80		Varenr. 40-80B		Varenr. 40-80T	
			5 meter	6 meter	7 meter	8 meter / lett	8 meter / betong	8 meter / tung						
			Varenr.	Stk	Varenr.	Stk	Varenr.	Stk	Varenr.	Stk	Varenr.	Stk	Varenr.	Stk
1		Sort fenderlist	60-225	1	60-225	1	60-225	1	60-225	1	60-225	1	60-225	1
2		Pontong	80-330	1	80-330	1	80-330	1	80-370	2	80-550	1	80-370	2
3		Pontongvinkel	60-217	2	60-217	2	60-217	2	60-217	4	60-217	2	60-217	4
3		Bolter M12x75 til pontongvinkel	11-12075	4	11-12075	4	11-12075	4	11-12075	8	11-12075	4	11-12075	8
3		Mutter M12 til pontongvinkel	13-12	4	13-12	4	13-12	4	13-12	8	13-12	4	13-12	8
10		Stålramme standard	S40-50	1	S40-60	1	S40-70	1	S40-80	1	S40-80	1	S40-80T	1
<i>Alternativ stålramme ved avslutninger:</i>														
10		Stålramme avslutning høyre	S40-50H	1	S40-60H	1	S40-70H	1	S40-80H	1	S40-80H	1		
10		Stålramme avslutning venstre	S40-50V	1	S40-60V	1	S40-70V	1	S40-80V	1	S40-80V	1		
Velg festebeslag (enten 5, 6 eller 7):														
5		T-skinnebeslag	60-214	2	60-214	2	60-214	2	60-214	4	60-214	4	60-214	4
6		Klammerbeslag 90mm	60-212	2	60-212	2	60-212	2	60-212	4	60-212	4	60-212	4
6		Klammerbeslag 95mm	60-211	2	60-211	2	60-211	2	60-211	4	60-211	4	60-211	4
6		Klammerbeslag 128mm	60-213	2	60-213	2	60-213	2	60-213	4	60-213	4	60-213	4
7		Faste beslag m1/emningsrør	60-208	2	60-208	2	60-208	2						
7		Faste beslag m/2 emningsrør							60-209	2	60-209	2	60-209	2
8		Bolt som fester beslag til utrigger	11-18110	2	11-18110	2	11-18110	2	11-18160	2	11-18160	2	11-18160	2
8		Mutter til bolt	13-18	2	13-18	2	13-18	2	13-18	2	13-18	2	13-18	2

GANGBAR UTRIGGER MED STREKKMETALLDEKKE – SAMMENSETNINGSTABELL (SIDE 2)

Nr	Bilde	Beskrivelse	Lengde på utrigger							
			Varenr. 40-100		Varenr. 40-100T		Varenr. 40-100F		Varenr. 40-120	
			10 meter / standard		10 meter / tung		10 meter / fast kai		12 meter	
		Varenr.	Stk	Varenr.	Stk	Varenr.	Stk	Varenr.	Stk	
1		Sort fenderlist	60-225	1	60-225	1	60-225	1	60-225	1
2		Pontong 550l	80-550	2	80-550	2	80-370	2	80-550	2
2		Pontong 370l							80-370	1
3		Pontongvinkel	60-217	4	60-217	4	60-217	4	60-217	6
3		Bolter til pontongvinkel	11-12075	8	11-12075	8	11-12075	8	11-12075	12
3		Mutter til pontongvinkel	13-12	8	13-12	8	13-12	8	13-12	12
10		Stålramme standard	S40-100	1	S40-100T	1	S40-100	1	S40-120	1
		<i>Alternativ stålramme ved avslutninger:</i>								
10		Stålramme avslutning høyre	S40-100H	1			S40-100H	1		
10		Stålramme avslutning venstre	S40-100V	1			S40-100V	1		
		Velg festebeslag (enten 5, 6 eller 7):								
5		T-skinnebeslag	60-214	4	60-214	4	60-214	4	60-214	4
6		Klammerbeslag 90mm	60-212	4	60-212	4	60-212	4	60-212	4
6		Klammerbeslag 95mm	60-211	4	60-211	4	60-211	4	60-211	4
6		Klammerbeslag 128mm	60-213	4	60-213	4	60-213	4	60-213	4
7		Faste beslag m1/emningsrør								
7		Faste beslag m/2 emningsrør	60-209	2	60-209	2	60-209	2	60-209	2
8		Bolt som fester beslag til utrigger	11-18160	2	11-18160	2	11-18160	2	11-18160	2
8		Mutter til bolt	13-18	2	13-18	2	13-18	2	13-18	2